

INSTRUCTION MANUAL
CAT. 71020, 71025, 71030, 71040
Branson Ultrasonic Benchtop Cleaners
Models 1800, 2800, 3800, 5800, and 8800



Electron Microscopy Sciences
1560 Industry Road Hatfield, PA 19440 P.O. Box 550
TEL: 215-412-8400 FAX: 215-412-8450
EMAIL: sgkcck@aol.com WEB: www.emsdiasum.com

WARNING

Do not place parts or containers directly on the bottom of the tank; use a tray or wire to suspend items. Direct placement can cause the units to fail.

Do not allow the solution to drop more than 3/8 inch (1 cm) below the operating level line.

Do not ever use alcohol, gasoline, or flammable solutions. Doing so could cause a fire or explosion. Use only water-based solutions.

Do not use mineral acids. These could damage the tank.

SAFETY PRECAUTIONS

Before using your Ultrasonic Bath, please read and thoroughly understand these safety precautions. Failure to follow them may result in serious personal injury or property damage.

To avoid electrical shock:

- Unplug from power source before filling or emptying the tank.
- Plug the unit into an appropriate grounded power socket.
- Connect the unit to a power supply using a properly sized overcurrent protection device. See label on the back of the unit for information of current rating.
- Keep the control panel and the area around the unit clean and dry—wipe up solution which spills over the tank brim. Water and high voltage can cause electrical shock.
- Do not operate the unit without proper grounding.
- Do not remove the grounding prong on the line cord plug.
- Do not disassemble your unit—high voltage inside the unit is dangerous.
- Do not immerse the unit in water.

To prevent personal and/or property damage:

- Use water-based solutions.
- Do not ever use alcohol, gasoline or flammable solutions. Doing so could cause a fire or explosion and will void your warranty. Use only water-based solutions.
- Do not ever use mineral acids. These could damage the tank.
- Do not touch the stainless steel tank or cleaning solution—they may be hot.
- Do not allow fluid temperature to exceed 158F (70C).
- Do not place your fingers or hands into the tank while the unit is operating. Doing so may cause discomfort and possible skin irritation. Avoid contact with solutions and provide adequate ventilation.
- Do not use solutions containing chlorine bleach.

Electron Microscopy Sciences

1560 Industry Road Hatfield, PA 19440 P.O. Box 550

TEL: 215-412-8400 FAX: 215-412-8450

EMAIL: sgkcck@aol.com WEB: www.emsdiasum.com

To prevent damage to the unit:

- Charge your solution regularly.
- Do not cover vents on the cover.
- Do not operate the unit dry.
- Do not place parts or containers directly on the bottom of the tank; use a tray or wire to suspend items. Failure to comply may cause transducer damage and will void your warranty.
- Do not allow the solution to drop more than 3/8 inch (1cm) below the operating level line with heat or ultrasonics on. Failure to comply may cause transducer and/or heater damage and will void your warranty.
- Turn off AC and heater switch before plugging/unplugging the line cord.

Sound level and energy savings:

- Do not operate the unit without a cover when possible.
- The sound pressure released by the unit depends on the size of the bath and the application, but is less than 80 dBA when used with a cover.
- To reduce the sound pressure, it is recommended to use a cover while ultrasonics are activated and to switch the ultrasonics on with the bath loaded when possible.

Electron Microscopy Sciences

1560 Industry Road Hatfield, PA 19440 P.O. Box 550

TEL: 215-412-8400 FAX: 215-412-8450

EMAIL: sgkcck@aol.com WEB: www.emsdiasum.com

Introduction

Each model is constructed using durable industrial style 40 kHz transducers. These provide increased ultrasonic power along with built in sweep frequency to ensure uniform ultrasonic activity throughout the bath. Models 1800 and 2800 have a molded dip in the left side of their rims to facilitate emptying of the solution from the tank. Models 3800, 5800, and 8800 have built in drains and are supplied with tank drain kits. Each model can be purchased in four different configurations:

- With a mechanical timer (M)
- With a mechanical timer plus heat (MH)
- With digital control and timer (CPX)
- With digital control, plus heat and timer (CPXH)



When you first fill your unit or refill it with a fresh solution, use warm water from the solution. Turn on the heater (if available), then turn on the ultrasonics (press the Sonics key or rotate the timer), add the cover and the solution will heat quickly to temperature.

Accessories for your unit

As parts cannot be placed on the tank bottom, accessories include beaker positioning covers, solid and perforated insert trays, mesh baskets, beakers, and support racks.

NOTE: Tank covers are included with every unit.

Electron Microscopy Sciences

1560 Industry Road Hatfield, PA 19440 P.O. Box 550

TEL: 215-412-8400 FAX: 215-412-8450

EMAIL: sgkcck@aol.com WEB: www.emsdiasum.com

Unpacking your unit

Please check your unit and its carton carefully for any external or internal damage. If you find damage, contact your shipping carrier immediately before contacting your distributor. Please retain your packaging for future use.

Installing your unit

Check the plate on the back of the unit for correct power requirements. Position your unit within easy reach of a standard grounded electrical outlet. Do not place the unit on a circuit which could become overloaded. If your unit does not operate correctly, first refer to the troubleshooting section for possible causes.

How Ultrasonics works

Ultrasonic sound is sound transmitted at frequencies generally beyond the range of human hearing. In your ultrasonic bath, ultrasonic sound (sonics) can be used for cleaning materials and part, and for dissolving, homogenizing, and degassing liquids. The following explains the process:

1. As the sound waves from the transducer radiate through the solution in the tank, they cause alternating high and low pressures in the solution.
2. During the low pressure stage, millions of microscopic bubbles form and grow. This process is called cavitation, meaning formation of cavities.
3. During the high pressure stage, the bubbles collapse or implode, releasing enormous amounts of energy.
4. For ultrasonic cleaning applications, these implosions act like an army of tiny scrub brushes. They work in all directions, attacking every surface and invading all recesses and openings.
5. This same energy can be used for other applications, such as liquid dissolving, homogenizations, and degassing.

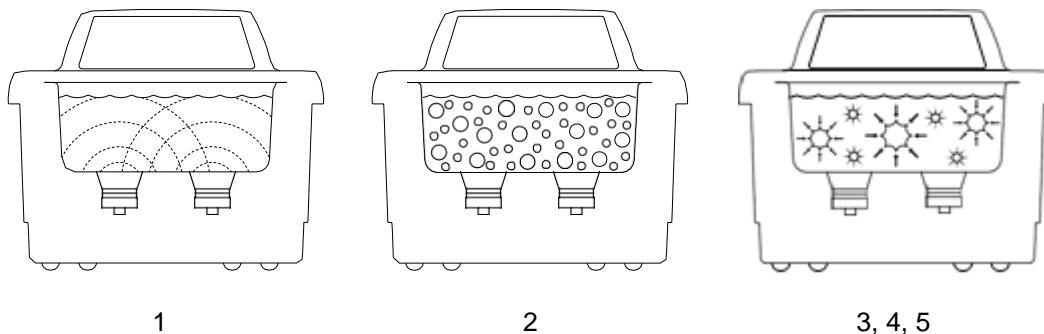

Electron Microscopy Sciences

1560 Industry Road Hatfield, PA 19440 P.O. Box 550

TEL: 215-412-8400 FAX: 215-412-8450

EMAIL: sgkcck@aol.com WEB: www.emsdiasum.com

Model name definition

Example:

CPX	1800	H	-E
Model	Tank Capacity	Heater	Region/Voltage
CPX: Digital	1800: ½ gal (1.91L)	Blank: No heater	Blank: North America (120 VAC)
M: Mechanical	2800: ¾ gal. (2.81L)	H: With heater	E: Europe (230 VAC)
	3800: 1 – ½ gal. (5.71L)		J: Japan (100 VAC)
	8800: 5 – ½ gal. (20.81L)		C: China (220 VAC)

NOTE:

- All models have a frequency of 40 kHz.
- In CPXH models, the temperature readout accuracy is $\pm 3C$ ($\pm 5.4F$).
- Models available for 120 V $\pm 10\%$, 50/60 Hz and 220 V $\pm 10\%$, 50/60 Hz operation.
- All 120 V units have CSA/UL or equivalent approval and comply with FCC regulations.
- All 220-230 V units meet CE standards.
- All units have a ground leakage current less than 0.50 ma.
- Operating temperature is from 5C to 40C (41F to 104F).

Electron Microscopy Sciences

1560 Industry Road Hatfield, PA 19440 P.O. Box 550

TEL: 215-412-8400 FAX: 215-412-8450

EMAIL: sgkcck@aol.com WEB: www.emsdiasum.com

Operating your Ultrasonic Bath

If this is the first time you are using the ultrasonic bath, please read this whole section before operating your unit.

M Series: Before you begin

CAUTION

- Do not place parts or containers directly on the bottom of the tanks; use a tray or wire to suspend items. Direct placement can cause the units to fail.
- Do not allow the solution to drop more than 3/8 inch (1 cm) below the operating level line with ultrasonics on.
- Do not ever use alcohol, gasoline, or flammable solutions. Do son could cause a fire or explosion. Use only water-based solutions.
- Do not ever use mineral acids. These could damage the tank.

Failure to comply with these cautions will void your warranty.

Step	Action
1	Select your cleaning solution.
2	Allow for the volume of the parts you will be cleaning and leaving room for the cleaning solution, fill the tank with warm tap water to the operating level line.
3	Add cleaning solution to the tank water.
4	Plug the unit into a grounded outlet.
5	For maximum efficiency, refer to "Optimizing your Ultrasonic Bath" before proceeding.

NOTE:

If this is the first time you are running the unit, or if you have changed cleaning solution, you must degas the solution. If not, skip to "Cleaning items (Treating samples)".

Electron Microscopy Sciences

1560 Industry Road Hatfield, PA 19440 P.O. Box 550

TEL: 215-412-8400 FAX: 215-412-8450

EMAIL: sgkcck@aol.com WEB: www.emsdiasum.com

M Series: Explanation of controls

M Series Tower

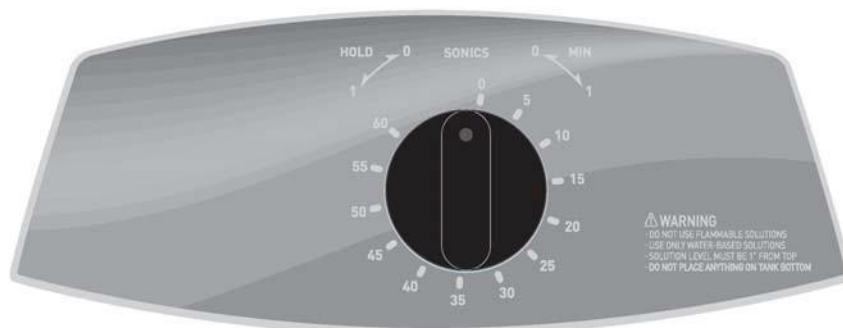

Control	Function
MAIN POWER SWITCH	<p>This switch is located on the back of the unit, next to the power cord receptacle.</p> <ul style="list-style-type: none"> - Press the I (on) side to power the unit. - Press the O (off) side to power the unit. <p>When operating the unit, normally leave the Main Power Switch in the I (on) position, and use the Timer Knob to activate ultrasonics.</p>
TIMER KNOB	<p>Activates ultrasonics and sets time.</p> <ul style="list-style-type: none"> - Turn clockwise for timed operation (0-60 minutes). - Turn counterclockwise to the HOLD position for continuous operation. - Turn to the zero position to turn unit OFF.

M Series: Operating your unit

Degassing

For initial cleaning solution degassing.

Step	Action
1	Turn Main Power Switch on.
2	Turn the Timer Knob clockwise to 5-10 and let the unit run to allow the solution to "degas".

Electron Microscopy Sciences

1560 Industry Road Hatfield, PA 19440 P.O. Box 550

TEL: 215-412-8400 FAX: 215-412-8450

EMAIL: sgkcck@aol.com WEB: www.emsdiasum.com

Cleaning items (Treating samples)

NOTE: To stop ultrasonics at any time, turn the Timer Knob to the zero position.

Step	Action
1	Turn Main Power Switch on.
2	Turn the Timer Knob clockwise to set the amount of time (0-60 minutes) you wish the items to be cleaned. Turn the Timer Knob counterclockwise to the HOLD position for continuous operation.
3	Place the items into a basket, perforated tray, or beakers in a positioning cover.
4	If using beakers or a solid tray, add cleaning solution to beakers or tray to cover the items.
5	Slowly lower the tray or beakers into the tank. Do not allow items to contact the tank bottom.
6	When items are clean, slowly remove them from the tank.
7	Rinse the clean items with clean water and dry them, if necessary.

Electron Microscopy Sciences

1560 Industry Road Hatfield, PA 19440 P.O. Box 550

TEL: 215-412-8400 FAX: 215-412-8450

EMAIL: sgkcck@aol.com WEB: www.emsdiasum.com

MH Series: Before you begin

CAUTION

- Do not place parts or containers directly on the bottom of the tanks; use a tray or wire to suspend items. Direct placement can cause the units to fail.
- Do not allow the solution to drop more than 3/8 inch (1 cm) below the operating level line with heat or ultrasonics on.
- Do not ever use alcohol, gasoline, or flammable solutions. Doing so could cause a fire or explosion. Use only water-based solutions.
- Do not ever use mineral acids. These could damage the tank.

Failure to comply with these cautions will void your warranty.

Step	Action
1	Select your cleaning solution.
2	Allowing for the volume of the parts you will be cleaning and leaving room for cleaning solution, fill the tank with warm tap water to the operating level line.
3	Add cleaning solution the tank water.
4	Plug the unit unto a grounded outlet.
5	For maximum efficiency, refer to "Optimizing your Ultrasonic Bath", before proceeding.

NOTE:

If this is the first time you are running the unit, or if you have changed cleaning solution, you must degas the solution. If not, skip to "Cleaning items (Treating samples)".

MH Series: Explanation of controls

MH Series Tower

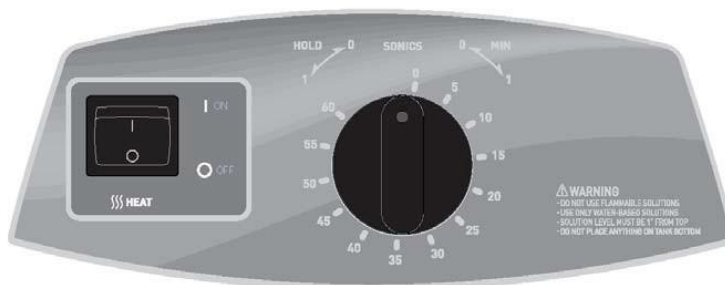

Electron Microscopy Sciences

1560 Industry Road Hatfield, PA 19440 P.O. Box 550

TEL: 215-412-8400 FAX: 215-412-8450

EMAIL: sgkcck@aol.com WEB: www.emsdiasum.com

Control	Function
MAIN POWER SWITCH	This switch is located on the back of the unit, next to the power cord receptacle. <ul style="list-style-type: none"> - Press the (on) side to power on the unit. - Press the ○ (off) side to power off the unit. When operating the unit, normally leave the Main Power Switch in the (on) position, and use the Timer Knob to activate ultrasonics.
HEAT SWITCH	Activates heat to 60C (140F) maximum.
TIMER KNOB	Activates ultrasonics and sets time. <ul style="list-style-type: none"> - Turn clockwise for timed operation (0-60 minutes). - Turn counterclockwise to the HOLD position for continuous operation. - Turn to the zero position to turn unit OFF.

MH Series: Operating your unit

Degassing

For initial cleaning solution degassing.

Step	Action
1	Turn Main Power Switch on.
2	Turn HEAT switch on.
3	Turn the Timer Knob clockwise to 5-10 and let the unit run to allow the solution to "degas".

Cleaning items (Treating samples)

NOTE: To stop ultrasonics at any time, turn the Timer Knob to the zero position.

Step	Action
1	Turn Main Power Switch on.
2	Turn the Timer Knob clockwise to set the amount of time (0-60 minutes) you wish the items to be cleaned. Turn the Timer Knob counterclockwise to the HOLD position for continuous operation.
3	Place the items into a basket, perforated tray, or beakers in a positioning cover.
4	If using beakers or a solid tray, add cleaning solution to beakers or tray to cover the items.
5	Slowly lower the tray or beakers into the tank. Do not allow items to contact the tank bottom.
6	When items are clean, slowly remove them from the tank.
7	Rinse the clean items with clean water and dry them, if necessary.

Electron Microscopy Sciences

1560 Industry Road Hatfield, PA 19440 P.O. Box 550

TEL: 215-412-8400 FAX: 215-412-8450

EMAIL: sgkck@aol.com WEB: www.emsdiasum.com

CPX Series: Before you begin

CAUTION

- Do not place parts or containers directly on the bottom of the tanks; use a tray or wire to suspend items. Direct placement can cause the units to fail.
- Do not allow the solution to drop more than 3/8 inch (1 cm) below the operating level line with ultrasonics on.
- Do not ever use alcohol, gasoline, or flammable solutions. Doing so could cause a fire or explosion. Use only water-based solutions.
- Do not ever use mineral acids. These could damage the tank.

Failure to comply with these cautions will void your warranty.

Step	Action
1	Select your cleaning solution.
2	Allowing for the volume of the parts you will be cleaning and leaving room for cleaning solution, fill the tank with warm tap water to the operating level line.
3	Add cleaning solution to the tank water.
4	Plug the unit into a grounded outlet.
5	For maximum efficiency, refer to "Optimizing your Ultrasonic Bath", before proceeding.

NOTE:

If this is the first time you are running the unit, or if you have changed cleaning solution, you must degas the solution. If not, skip to "Cleaning items (Treating samples)".

Electron Microscopy Sciences

1560 Industry Road Hatfield, PA 19440 P.O. Box 550

TEL: 215-412-8400 FAX: 215-412-8450

EMAIL: sgkcck@aol.com WEB: www.emsdiasum.com

CPX Series: Explanation of controls

CPX Series Tower



Control	Function
MAIN POWER SWITCH	<p>This switch is located on the back of the unit, next to the power cord receptacle.</p> <ul style="list-style-type: none"> - Press the (on) side to power the unit. - Press the ○ (off) side to power the unit. <p>When operating the unit, normally leave the Main Power Switch in the (on) position, and use the On/Standby key to switch between the operating state and standby state.</p>
ON/STANDBY	When the Main Power Switch on the rear panel is in the (on) position, press the power on/off the unit.
UP/DOWN KEYS	Press to increase/decrease ultrasonic or degassing cycle time (hold for quick increments/decrements). Time values are circular, pressing from 99 minutes takes you to Constant Sonics Mode and “-” on the display and then to 1 minutes. Pressing from 1 minutes takes you to Constant Sonics Mode and then 99 minutes. During power-up, use to select high or low ultrasonic power output.
SONICS	Press to activate ultrasonics. If running in Timed Mode, a timer will begin to count down and ultrasonics will stop at 0 minutes. In Constant Sonics Mode, and “-” on the display, timer has no function. Press key again to deactivate ultrasonics. If running in Timed Mode, press and keys to adjust the ultrasonic cycle time (adjustable from 1 to 99 minutes).
DEGAS	Press to degas the solution or to run a degas application. A default timer of 5 minutes will begin to count down and degassing will stop at 0 minutes. Press key again to stop degassing the solution. During a degas cycle, press and keys to adjust the degas cycle time (adjustable from 1 to 99 minutes).

Electron Microscopy Sciences





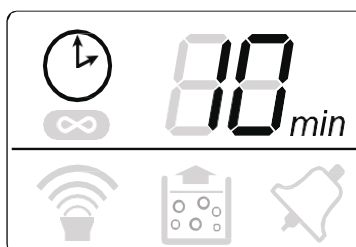

1560 Industry Road Hatfield, PA 19440 P.O. Box 550

TEL: 215-412-8400 FAX: 215-412-8450

EMAIL: sgkcck@aol.com WEB: www.emsdiasum.com

CPX Series: LCD description



Item	Function
 Power Level	<p>Displayed for 15 s only during power-up, shows the current ultrasonic output power selection.</p> <p>Press the Sonics () or Degas key () to go into normal operating mode.</p> <p>Press  or  key to change between high (HI) and low (LO) power ultrasonics.</p>
Sonics/ Degas Timer 	<p>Displays the duration of a timed ultrasonic or degas cycle.</p> <p>Press  and  keys to adjust ultrasonic or degassing cycle time (adjustable from 1 to 99 minutes).</p> <p>In Constant Sonics Mode, "--" is displayed.</p>
Constant Sonics 	<p>Indicates the unit is operating in Constant Sonics Mode.</p> <p>In Constant Sonics Mode, sonics will remain on until the Sonics key is pressed or the unit is turned off.</p>
Sonics On 	<p>Indicates sonics are active.</p> <p>If running in Timed Mode, ultrasonics will remain on until the timer reaches 0 minutes.</p> <p>In Constant Sonics Mode, ultrasonics will remain on until the Sonics key is pressed or the unit is turned off.</p>
Degas On 	<p>Indicates the unit is in Degas Mode.</p> <p>In Degas Mode, degassing will continue until the timer reaches 0 minutes.</p>
Alarm 	<p>Alarm Bell icon flashes when the unit encounters an abnormal operating condition.</p>

Electron Microscopy Sciences

1560 Industry Road Hatfield, PA 19440 P.O. Box 550

TEL: 215-412-8400 FAX: 215-412-8450

EMAIL: sgkcck@aol.com WEB: www.emsdiasum.com

CPX Series: Operating your unit

Degassing

For initial cleaning solution degassing.

NOTE: To stop degassing at any time, press the Degas key.

Step	Action
1	Turn Main Power switch on.
2	Press the On/Standby key (⏻) to turn on the unit.
3	Press Degas key (☼) once to start the degas process. Default degas time is 5 minutes. If necessary, use ⏮/⏭ keys to alter degas time during a degas cycle. NOTE: Refer to page 41 for information on degassing.
4	After completing the degas time, you are ready to set operating parameters.

Cleaning items (Treating samples)

NOTE: To stop ultrasonics at any time, press the Sonics key.

Step	Action
1	Turn Main Power switch on.
2	Press the On/Standby key (⏻) to turn on the unit.
3	Set the amount of time you wish the items to be cleaned, or select Constant Sonics Mode: <ul style="list-style-type: none"> • Use ⏮/⏭ keys to increase/decrease cycle time (hold for quick increments/decrements). • Pressing ⏮ key from 99 minutes or ⏭ from 1 minutes takes you to Constant Sonics Mode ∞ and "--" on the display).

Electron Microscopy Sciences

1560 Industry Road Hatfield, PA 19440 P.O. Box 550

TEL: 215-412-8400 FAX: 215-412-8450

EMAIL: sgkcck@aol.com WEB: www.emsdiasum.com

Step	Action
4	Press the Sonics key ) to activate ultrasonics.
5	Place the items into a basket, perforated tray, or beakers in a positioning cover.
6	If using beakers or a solid tray, add cleaning solution to beakers or tray to cover the items.
7	Slowly lower the tray or beakers into the tank. Do not allow items to contact the tank bottom.
8	When items are clean, slowly remove them from the tank.
9	Rinse clean items with clean, warm water and dry, if necessary.

Electron Microscopy Sciences

1560 Industry Road Hatfield, PA 19440 P.O. Box 550

TEL: 215-412-8400 FAX: 215-412-8450

EMAIL: sgkcck@aol.com WEB: www.emsdiasum.com

CPXH Series: Before you begin

▲ CAUTION ▲

- Do not place parts or containers directly on the bottom of the tanks; use a tray or wire to suspend items. Direct placement can cause the units to fail.
- Do not allow the solution to drop more than 3/8 inch (1 cm) below the operating level line with heat or ultrasonics on.
- Do not ever use alcohol, gasoline or flammable solutions. Doing so could cause a fire or explosion. Use only water-based solutions.
- Do not ever use mineral acids. These could damage the tank.

Failure to comply with these cautions will void your warranty.

NOTE

If this is the first time you are running the unit, or if you have changed cleaning solution, you must degas the solution. If not, skip to "Cleaning Items (Treating Samples) in Timed Sonics Mode."

Step	Action
1	Select your cleaning solution (refer to page 49 for solution effects on metals).
2	Allowing for the volume of the parts you will be cleaning and leaving room for cleaning solution, fill the tank with warm tap water to the operating level line.
3	Add cleaning solution to the tank water.
4	Plug the unit into a grounded outlet.
5	For maximum efficiency, refer to page 40, "Optimizing Your Ultrasonic Bath," before proceeding.

Electron Microscopy Sciences

1560 Industry Road Hatfield, PA 19440 P.O. Box 550







TEL: 215-412-8400 FAX: 215-412-8450

EMAIL: sgkcck@aol.com WEB: www.emsdiasum.com

CPXH Series: Explanation of controls

CPXH Series Tower













Control	Function
MAIN POWER SWITCH	<p>This switch is located on the back of the unit, next to the power cord receptacle.</p> <ul style="list-style-type: none"> Press the I (on) side to power on the unit. Press the O (off) side to power off the unit. <p>When operating the unit, normally leave the Main Power switch in the I (on) position, and use the On/Standby key to switch between the operating state and standby state.</p>
ON/STANDBY 	<p>When the Main Power switch on the rear panel is in the I (on) position, press to power on/off the unit.</p>
UP/DOWN KEYS  	<p>Press to increase/decrease ultrasonic or degassing cycle time (hold for quick increments/decrements).</p> <p>Time values are circular, pressing  from 99 minutes takes you to 1 minutes. Pressing  from 1 minutes takes you to 99 minutes.</p> <p>If the Fn key was pressed, use the   keys to adjust function settings.</p>

Electron Microscopy Sciences

1560 Industry Road Hatfield, PA 19440 P.O. Box 550

TEL: 215-412-8400 FAX: 215-412-8450

EMAIL: sgkcck@aol.com WEB: www.emsdiasum.com



Control	Function
HEAT 	Press to turn heater on/off. Heater will shut off when set temperature is attained.
SONICS 	Press to activate ultrasonics. If running in Timed Mode, a timer will begin to count down and ultrasonics will stop at 0 minutes. In Constant Sonics Mode  and " - - - " on the display), timer has no function. Press key again to deactivate ultrasonics. If running in Timed Mode, press  and  keys to adjust the ultrasonic cycle time (adjustable from 1 to 99 minutes).
DEGAS 	Press to degas the solution or to run a degas application. The degas timer will begin to count down from its current setting and degassing will stop at 0 minutes. Press key again to stop degassing the solution. During a degas cycle, press  and  keys to adjust degas time (adjustable from 1 to 99 minutes). NOTE: Refer to page 41 for information on degassing.
AUTO 	Press to begin an auto cycle. In Auto Mode, the following actions are carried out automatically by the controller: <ul style="list-style-type: none"> • Heater is turned on to bring bath to set temperature. • When set temperature is reached, ultrasonics are activated. The unit will abort the auto cycle and flash the  icon if set temperature is not reached within a 120-minute period. • When ultrasonics timer reaches 0 minutes, the auto cycle is finished. If at any point during an auto cycle the degas key is pressed, a degas cycle will begin. If ultrasonics has already started, the ultrasonics timer will restart after the degas period.

Electron Microscopy Sciences

1560 Industry Road Hatfield, PA 19440 P.O. Box 550

TEL: 215-412-8400 FAX: 215-412-8450

EMAIL: sgkck@aol.com WEB: www.emsdiasum.com







Control	Function
<p data-bbox="396 302 532 331">FUNCTION</p> <p data-bbox="440 331 493 401">Fn</p>	<p data-bbox="537 302 1213 331">Press the Fn key to access less-frequently used functions.</p> <div data-bbox="634 338 1117 846"> <pre> graph TD RS[Ready State] -- Fn 1x --> ST[Set Target Temp.] ST -- Fn 2x --> CS[Set Constant Sonics] CS -- Fn 3x --> SPL[Set Power Level] SPL -- Fn 4x --> STU[Set Temp. Units] STU -- Fn 5x --> SDT[Set Degas Time] SDT -- Fn 6x --> SST[Set Sonics Time] SST -- Fn 1x --> RS </pre> </div> <p data-bbox="537 869 1213 926">The appropriate icon will flash to indicate which option is selected.</p> <p data-bbox="537 930 1213 987">If no key is pressed after 15 seconds the unit will save any changes and return to the Ready state.</p> <p data-bbox="537 991 1213 1047">Press the Fn key again after making any changes to scroll through the rest of the options and return to the Ready state.</p> <p data-bbox="537 1079 932 1108">The following options are available:</p> <ul data-bbox="537 1125 1154 1182" style="list-style-type: none"> • Set Temperature: Press  and  keys to increase/decrease the bath set temperature. <div data-bbox="643 1188 1117 1465"> </div>

Electron Microscopy Sciences

1560 Industry Road Hatfield, PA 19440 P.O. Box 550

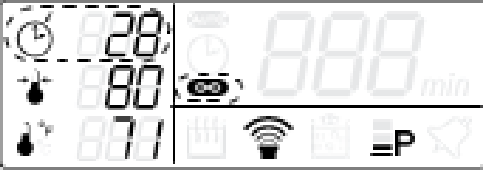
TEL: 215-412-8400 FAX: 215-412-8450

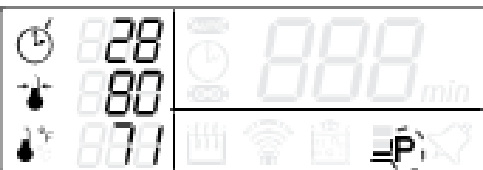
EMAIL: sgkck@aol.com WEB: www.emsdiasum.com

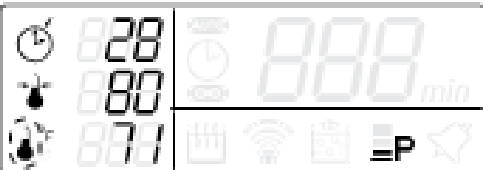







Control	Function
<p data-bbox="383 289 521 321">FUNCTION</p> <div data-bbox="427 331 488 411" style="border: 1px solid black; padding: 2px; width: fit-content; margin: 10px auto;">Fn</div>	<ul style="list-style-type: none"> <li data-bbox="521 304 1229 420"> <p>• Timed/Constant Sonics: Press  key to select Constant Sonics Mode  and " - - - " on the display). Press  key to select Timed Sonics Mode.</p> <div style="display: flex; align-items: center; justify-content: center; margin: 10px 0;"> <div data-bbox="641 441 763 514" style="border: 1px solid black; padding: 2px; margin-right: 20px;">Fn (2x)</div> <div data-bbox="893 441 1039 514" style="border: 1px dashed black; border-radius: 50%; padding: 5px; text-align: center;">Indicates blinking</div> </div>  <li data-bbox="521 724 1229 840"> <p>• Full/Low Power: Press  key to select full power ultrasonic output. Press  key to select low power ultrasonic output.</p> <div style="display: flex; align-items: center; justify-content: center; margin: 10px 0;"> <div data-bbox="641 861 763 934" style="border: 1px solid black; padding: 2px; margin-right: 20px;">Fn (3x)</div> <div data-bbox="893 861 1039 934" style="border: 1px dashed black; border-radius: 50%; padding: 5px; text-align: center;">Indicates blinking</div> </div>  <li data-bbox="521 1144 1229 1260"> <p>• Temperature Units: Press  key to select Fahrenheit (°F). Press  key to select Celsius (°C).</p> <div style="display: flex; align-items: center; justify-content: center; margin: 10px 0;"> <div data-bbox="641 1249 763 1323" style="border: 1px solid black; padding: 2px; margin-right: 20px;">Fn (4x)</div> <div data-bbox="893 1249 1039 1323" style="border: 1px dashed black; border-radius: 50%; padding: 5px; text-align: center;">Indicates blinking</div> </div> 

Electron Microscopy Sciences

1560 Industry Road Hatfield, PA 19440 P.O. Box 550

TEL: 215-412-8400 FAX: 215-412-8450

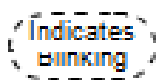
EMAIL: sgkck@aol.com WEB: www.emsdiasum.com

Control	Function
<p>FUNCTION</p> <p></p>	<p>Degas Time: Press   keys to increase/decrease degas time (hold for quick increments/decrements).</p> <p>Time values are circular, pressing  from 99 minutes takes you to 1 minutes. Pressing  from 1 minutes takes you to 99 minutes.</p> <p> </p> 

CPXH Series: LCD description











Electron Microscopy Sciences

1560 Industry Road Hatfield, PA 19440 P.O. Box 550

TEL: 215-412-8400 FAX: 215-412-8450

EMAIL: sgkck@aol.com WEB: www.emsdiasum.com









Item	Function
Sonics/ Degas Set Time 	Displays the set time for a timed ultrasonic or degas cycle. Press  and  keys to adjust ultrasonic or degassing cycle time (adjustable from 1 to 99 minutes). In Constant Sonics Mode, " - - " is displayed.
Set Temperature 	Displays the target temperature. Temperature units are indicated by the °F (for Fahrenheit) or °C (for Celsius) right of the Current Temperature icon.
Current Temperature 	Displays the current tank temperature as measured by the unit. Temperature units are indicated right of the icon as either °F (For Fahrenheit) or °C (for Celsius). Units can be switched using the Fn key. See Fn key description on page 29.
Sonics/ Degas Timer 	Displays the remaining time of a running timed ultrasonic or degas cycle. Press  and  keys to adjust ultrasonic or degassing cycle time (adjustable from 1 to 99 minutes).

Electron Microscopy Sciences

1560 Industry Road Hatfield, PA 19440 P.O. Box 550

TEL: 215-412-8400 FAX: 215-412-8450

EMAIL: sgkcck@aol.com WEB: www.emsdiasum.com

Item	Function
Auto 	Indicates the unit is in Auto Mode. In Auto Mode, the following actions are carried out automatically by the controller: <ul style="list-style-type: none"> • Heater is turned on to bring bath to set temperature. • When set temperature is reached, ultrasonics are activated. The unit will abort the auto cycle and flash the  icon if set temperature is not reached within a 120-minute period. • When ultrasonics timer reaches 0 minutes, the auto cycle is finished. If at any point during an auto cycle the degas key is pressed, a degas cycle will begin. If ultrasonics has already started, the ultrasonics timer will restart after the degas period.
Constant Sonics 	Indicates the unit is operating in Constant Sonics Mode. In Constant Sonics Mode, ultrasonics will remain on until the Sonics key is pressed or the unit is turned off.
Heat 	Indicates the heater is on. Heater will shut off when set temperature is attained.
Sonics On 	Indicates sonics are active. If running in Timed Mode, ultrasonics will remain on until the timer reaches 0 minutes. In Constant Sonics Mode, ultrasonics will remain on until the Sonics key is pressed or the unit is turned off.
Degas On 	Indicates the unit is in Degas Mode. In Degas Mode, degassing will continue until the timer reaches 0 minutes. NOTE: Refer to page 41 for information on degassing.
Power Level 	Indicates the ultrasonic power output selection: <ul style="list-style-type: none"> • Four bars indicate high power ultrasonics. • Two bars indicate low power ultrasonics.
Alarm 	Alarm Bell icon flashes when the unit encounters an abnormal operating condition. NOTE: Refer to page 51 for information on troubleshooting.

Electron Microscopy Sciences

1560 Industry Road Hatfield, PA 19440 P.O. Box 550

TEL: 215-412-8400 FAX: 215-412-8450

EMAIL: sgkcck@aol.com WEB: www.emsdiasum.com

CPXH Series: Operating your unit

Degassing

For initial cleaning solution degassing.

NOTE: To stop degassing at any time, press the Degas key.

Step	Action
1	Turn Main Power switch on.
2	Press the On/Standby key (⏻) to turn on the unit.
3	Default degas time is 5 minutes. To change the degas time, press the Fn key until the Degas icon (⏻) appears and the Set Time icon (⌚) flashes. Then press the ⬆️ ⬇️ keys to change the degas time.
4	Press Degas key (⏻) once to start the degas process. If necessary, use ⬆️ ⬇️ keys to alter degas time during a degas cycle. NOTE: Refer to page 41 for information on degassing.
5	After completing the degas time, you are ready to set operating parameters.

Ultrasonic operating modes

Mode	Action
Timed Sonics	In Timed Sonics Mode, a timer will begin to count down and ultrasonics will remain on until the timer reaches 0 minutes. For instructions on operating in Timed Sonics Mode, see page 34.
Constant Sonics	In Constant Sonics Mode ultrasonics will remain on until the Sonics key is pressed or power is turned off to the unit. For instructions on operating in Constant Sonics Mode, see page 35.
Auto	In Auto mode ultrasonics will start once set temperature is attained. Ultrasonics will remain on until the timer reaches 0 minutes. For instructions on operating in Auto Mode, see page 36.

Electron Microscopy Sciences

1560 Industry Road Hatfield, PA 19440 P.O. Box 550

TEL: 215-412-8400 FAX: 215-412-8450

EMAIL: sgkck@aol.com WEB: www.emsdiasum.com

Cleaning items (Treating samples) in Timed Sonics Mode

NOTE: To stop ultrasonics at any time, press the Sonics key.

Step	Action
1	Turn Main Power switch on.
2	Press the On/Standby key (⏻) to turn on the unit.
3	If necessary degas the liquid. See page 33 for instructions.
4	Set the amount of time you wish the items to be cleaned: <ul style="list-style-type: none"> Use ▲/▼ keys to increase/decrease cycle time (hold for quick increments/decrements).
5	Set the tank temperature: <ul style="list-style-type: none"> Press the Fn key until the Set Temperature icon (°C) flashes. Press the ▲/▼ keys to alter the setting to the tank temperature you wish to reach. Press the HEAT key (🔥) once to activate heat. The Heat icon (🔥) appears. <p>NOTE: Units can be switched between °F or °C using the Fn key. See Fn key description on page 29.</p>
6	Set the ultrasonic power level: <ul style="list-style-type: none"> Press the Fn key until the Power Level icon (⏻) flashes. Press the ▲ key to select high power ultrasonics or press the ▼ key to select low power ultrasonics.
7	Press the Sonics key (🔊) to activate ultrasonics.
8	Place the items into a basket, perforated tray, or beakers in a positioning cover.
9	If using beakers or a solid tray, add cleaning solution to beakers or tray to cover the items.
10	Slowly lower the tray or beakers into the tank. Do not allow items to contact the tank bottom.
11	When items are clean, slowly remove them from the tank.
12	Rinse clean items with clean, warm water and dry, if necessary.

Electron Microscopy Sciences

1560 Industry Road Hatfield, PA 19440 P.O. Box 550

TEL: 215-412-8400 FAX: 215-412-8450

EMAIL: sgkcck@aol.com WEB: www.emsdiasum.com

Cleaning items (Treating samples) in Constant Sonics Mode

NOTE: To stop ultrasonics at any time, press the Sonics key.

Step	Action
1	Turn Main Power switch on.
2	Press the On/Standby key (⏻) to turn on the unit.
3	If necessary degas the liquid. See page 33 for instructions.
4	Change sonics mode: <ul style="list-style-type: none"> • Press the Fn key until the Constant Sonics icon (∞) and the Set Time icon (⌚) flash. • Press the ⬆️ key to select Constant Sonics Mode.
5	Set the tank temperature: <ul style="list-style-type: none"> • Press the Fn key until the Set Temperature icon (🌡️) flashes. • Press the ⬆️ ⬇️ keys to alter the setting to the tank temperature you wish to reach. • Press the HEAT key (🔥) once to activate heat. The Heat icon (🔥) appears. <p>NOTE: Units can be switched between °F or °C using the Fn key. See Fn key description on page 29.</p>
6	Set the ultrasonic power level: <ul style="list-style-type: none"> • Press the Fn key until the Power Level icon (⚡) flashes. • Press the ⬆️ key to select high power ultrasonics or press the ⬇️ key to select low power ultrasonics.
7	Press the Sonics key (🔊) to activate ultrasonics.
8	Place the items into a basket, perforated tray, or beakers in a positioning cover.
9	If using beakers or a solid tray, add cleaning solution to beakers or tray to cover the items.
10	Slowly lower the tray or beakers into the tank. Do not allow items to contact the tank bottom.
11	When items are clean, slowly remove them from the tank.
12	Rinse clean items with clean, warm water and dry, if necessary.

Electron Microscopy Sciences

1560 Industry Road Hatfield, PA 19440 P.O. Box 550

TEL: 215-412-8400 FAX: 215-412-8450

EMAIL: sgkck@aol.com WEB: www.emsdiasum.com

Cleaning items (Treating samples) in Auto Mode

NOTE: To stop ultrasonics at any time, press the Sonics key.

Step	Action
1	Turn Main Power switch on.
2	Press the On/Standby key (⏻) to turn on the unit.
3	If necessary degas the liquid. See page 33 for instructions.
4	Set the amount of time you wish the items to be cleaned: <ul style="list-style-type: none"> Use ⬆/⬇ keys to increase/decrease cycle time (hold for quick increments/decrements).
5	Set the tank temperature: <ul style="list-style-type: none"> Press the Fn key until the Set Temperature icon (🌡) flashes. Press the ⬆/⬇ keys to alter the setting to the tank temperature you wish to reach. Press the HEAT key (🔥) once to activate heat. The Heat icon (🔥) appears. <p>NOTE: Units can be switched between °F or °C using the Fn key. See Fn key description on page 29.</p>
6	Set the ultrasonic power level: <ul style="list-style-type: none"> Press the Fn key until the Power Level icon (⚡) flashes. Press the ⬆ key to select high power ultrasonics or press the ⬇ key to select low power ultrasonics.
7	Press the Auto key (⏻) to begin Auto Cycle. Heater will turn on and sonics will start once set temperature is attained.
8	Place the items into a basket, perforated tray, or beakers in a positioning cover.
9	If using beakers or a solid tray, add cleaning solution to beakers or tray to cover the items.
10	Slowly lower the tray or beakers into the tank. Do not allow items to contact the tank bottom.
11	When items are clean, slowly remove them from the tank.
12	Rinse clean items with clean, warm water and dry, if necessary.

Electron Microscopy Sciences

1560 Industry Road Hatfield, PA 19440 P.O. Box 550

TEL: 215-412-8400 FAX: 215-412-8450

EMAIL: sgkck@aol.com WEB: www.emsdiasum.com

CPXH temperature calibration

The CPXH unit temperature measurement is factory calibrated. Use the following instructions to perform periodic calibrations:

Step	Action
1	The ultrasonic bath liquid may be at room temperature or may be heated-up to a desired operating temperature (e.g. 40 °C).
2	Press the Fn key 4 times until the Current Temperature icon (🌡️) starts blinking. Press the Δ key to select °F. Press the Fn key 2 more times to return to the Ready State.
3	Press the On/Standby key (🔘) to turn off the unit.
4	Simultaneously, press both the On/Standby (🔘) and the Fn key. Only the bottom left digits and the Current Temperature icon (🌡️) should turn on.
5	Stir the solution for 15 seconds to ensure thermal uniformity.
6	Wait 2 minutes after turning the unit on before taking measurements. This allows for the display to be properly updated.
7	Use the Δ / ∇ keys to change the display temperature to match the actual tank temperature.
8	Press the On/Standby key (🔘) to end calibration.

Draining your unit



Models 1800 and 2800 do not have a drain. TO empty, use the indented side of the rim to pour the used solution into a waste disposal unit, rinse the tank thoroughly and refill with new solution.

Electron Microscopy Sciences

1560 Industry Road Hatfield, PA 19440 P.O. Box 550

TEL: 215-412-8400 FAX: 215-412-8450

EMAIL: sgkcck@aol.com WEB: www.emsdiasum.com



Models 3800, 5800, and 8800 include a drain and valve kit.

Step	Action
1	Place the unit to allow easy reach of the drain tube into a waste disposal unit.
2	Remove the thread protecting cap from the end of the unit's drain pipe. This will expose the white teflon sealing tape on the drain pipe's threads.

Electron Microscopy Sciences

1560 Industry Road Hatfield, PA 19440 P.O. Box 550

TEL: 215-412-8400 FAX: 215-412-8450

EMAIL: sgkcck@aol.com WEB: www.emsdiasum.com

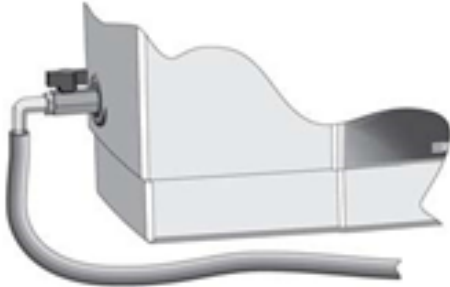
Step	Action
3	<p>Hand tighten the drain valve onto the drain pipe over the white teflon sealing tape. Finish tightening the valve in place using an adjustable or a 21mm wrench. Tighten the valve no more than one full turn when using the wrench until the handle is on top.</p> <p>CAUTION: Over tightening of the valve can cause damage to the ultrasonic tank. Always use teflon sealing tape or a sealing paste designed for use with stainless steel if retightening or retitting of the drain valve is required.</p>  <p>The diagram shows a grey ultrasonic tank with a control panel on top. A drain valve is attached to the side of the tank. A hose adaptor is connected to the valve, and a grey hose is attached to the adaptor. The label 'Hose Adapt' is placed next to the adaptor. The brand name 'BRANSON' is visible on the side of the tank.</p>
4	<p>Hand tighten the hose adaptor into the end of the drain valve. Slide the drain tube over the barbed hose adaptor end.</p>  <p>The diagram shows a close-up of the drain valve on the side of the tank. A hose adaptor is being inserted into the valve. A grey hose is attached to the adaptor. The label 'Hose Adapt' is placed next to the adaptor.</p>
5	<p>Close the drain valve by turning the handle perpendicular to the valve body and the unit is ready to fill with solution. To open the valve and drain the tank, turn the handle so that it is in line with the valve body.</p>

Electron Microscopy Sciences

1560 Industry Road Hatfield, PA 19440 P.O. Box 550

TEL: 215-412-8400 FAX: 215-412-8450

EMAIL: sgkck@aol.com WEB: www.emsdiasum.com

Optimizing your Ultrasonic Bath: Tanks

Cleaning – Check the tank for contamination whenever you change solution. If necessary, remove contaminants with a nonabrasive cloth and water.

Emptying – Always unplug the unit before emptying the tank. Empty the solution into a waste disposal unit.

Filling – Always unplug the line cord before filling the tank. Fill the tank to the operating level (with beaker/tray in place), using warm tap water.

Low solution level – Will cause the unit to fall. When you remove heavy or bulky loads from the tank, the solution level may drop below the operating level. If so, be sure to replace lost solution and degas, if necessary, depending on the amount used.

Overload – Do not rest any items on the tank bottom. Weight on the tank bottom dampens sound energy and will cause damage to the transducer. Instead, use a tray and/or beaker positioning cover to support all items. Allow at least 1 inch (2.5 cm) between the tank bottom and the beaker or receptacle for adequate cavitation.

Covers – Allow the unit to heat up faster, to a higher temperature, and avoid excessive liquid evaporation. However, obstructing the cover vents will cause the unit to overheat.

Optimizing your Ultrasonic Bath : Temperature

Heater – The heater may cause some discoloration of the tank wall. This is normal and will not affect the performance of the unit.

Solution – The fastest method to heat your ultrasonic bath is to fill with warm solution, use heat, ultrasonics (which also adds heat), and a cover.

Over temperature protection (CPXH only) – The unit will shut down at 75C (167F) and display will go blank with only the alarm icon remaining on. Turn the unit off and allow it to cool down. For a faster cooldown, replace some of the warm solution with cold solution.

Solution temperature measurement

The following instructions provide an accurate method to obtain consistent thermal measurements using a calibrated temperature measurement instrument. These readings can be used for cleaning process control or to verify the accuracy of the CPXH temperature readings.

Electron Microscopy Sciences

1560 Industry Road Hatfield, PA 19440 P.O. Box 550

TEL: 215-412-8400 FAX: 215-412-8450

EMAIL: sgkcck@aol.com WEB: www.emsdiasum.com

Step	Action
1	Ensure that sonics and heaters are off.
2	Stir the solution for 15 seconds to ensure thermal uniformity.
3	For CPXH models, wait 2 minutes after turning the unit on before taking measurements. This allows for the display to be properly updated.
4	Suspend a thermocouple in the bath without allowing the probe to touch the tank walls.

Solution

Solution activity - the amount of visible activity is not necessarily related to optimum cavitation for cleaning.

Degassing 1 - fresh solutions contain many dissolved gases (usually air), which reduce effective ultrasonic action. Although solutions will naturally degas over time, using Degas Mode speeds up the degassing process. Solutions that have been sitting unused for 24 hours or longer have reabsorbed some gases.

Degassing 2 - degassing mode is also used where gas has to be removed from liquids or samples.

Heat - increases the chemical activity of cleaning solutions.

Solvents - never use solvents. Vapors of flammable solutions will collect under the unit, where ignition is possible from electrical components.

Surface tension - can be reduced by adding solution to the bath. Reduced surface tension will increase cavitation intensity and enhance cleaning.

Renewal – Replace cleaning solutions often to increase ultrasonic cleaning activity. Solutions, as with most chemicals, will become depleted over time. Solutions can become contaminated with suspended soil particles which coat the tank bottom, inhibiting ultrasonic activity.



Electron Microscopy Sciences

1560 Industry Road Hatfield, PA 19440 P.O. Box 550

TEL: 215-412-8400 FAX: 215-412-8450

EMAIL: sgkcck@aol.com WEB: www.emsdiasum.com

Application hints

 CAUTION 
<ul style="list-style-type: none">▪ Never clean novelty or inexpensive jewelry in the ultrasonic bath. The combination of heat and vibration may loosen a cement-held setting.▪ Never clean gemstones such as emerald, amethyst, pearl, opal, coral, turquoise, peridot or lapis lazuli in the ultrasonic bath.

First time cleaning - first experiment with one piece, then proceed with the remainder.

Solution level - Be sure to maintain solution level within 1/2 inch (1.3 cm) of the tank's "operating level" line. Surface activity can vary with liquid level.

Load size - It is faster and more efficient to run several small loads rather than a few big loads.

Placing items - Never allow items to sit on the bottom of the tank. Always place them in a tray or beaker or suspend in the solution.

Rinsing items - After cleaning, use a clean water bath to rinse away chemicals adhering to items.

Lubricating items - When necessary, re-lubricate items immediately after cleaning.

Drying items - Air drying at room temperature works for some items. Place parts requiring faster drying time under hot air blowers or in ovens

Cleaning methods

There are two methods of cleaning – direct and indirect. Each has advantages and disadvantages, however, it is best to run tests using both methods in order to determine which one produces the best results for you.

Electron Microscopy Sciences

1560 Industry Road Hatfield, PA 19440 P.O. Box 550

TEL: 215-412-8400 FAX: 215-412-8450

EMAIL: sgkcck@aol.com WEB: www.emsdiasum.com

Direct cleaning method

How it works:

- Fill the tank with warm water and a cleaning solution.
- Place the items to be cleaned in a perforated tray and lower them into the tank. You can also suspend items on a wire and then immerse them in the solution.
- The advantages of this method are the simplicity of operation and cleaning effectiveness.

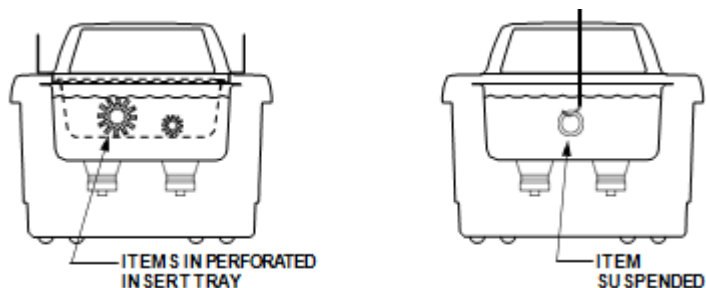

Indirect cleaning method

How it works:

- Fill the tank with warm water and a cleaning solution. The tank can be filled with any amount of diluted solution as long as it reaches the water level line once the items to be cleaned and accessories are placed into the tank.
- Pour your solution medium into one or more beakers or into a solid insert tray.
- Place the beakers in a beaker positioning cover or a solid insert tray to fit your unit. Beakers should not touch the tank's bottom.
- The advantages of this method are:
 - Removed soil stays in the beaker or tray so that you can easily examine, filter or discard it.
 - You can use one more solutions at the same time: (1) two completely different cleaning solutions; (2) one beaker or tray with a cleaning solution and one with a rinse solution.
 - Cleaning solution in your tank needs to be changed less often.

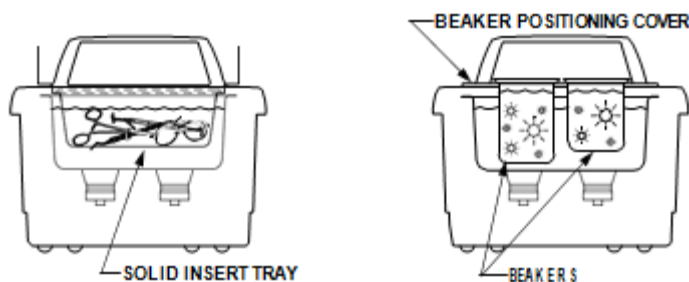

Electron Microscopy Sciences

1560 Industry Road Hatfield, PA 19440 P.O. Box 550

TEL: 215-412-8400 FAX: 215-412-8450

EMAIL: sgkcck@aol.com WEB: www.emsdiasum.com

Non-cleaning application

This method can be used for sample preparation, which includes degassing liquids, mixing, homogenization, dissolving solids, cell lysing and dispersion of particles.

How it works:

- Fill the tank with water and wetting agent. The tray or beakers can be filled with any amount of solution as long as the water in the tank outside the tray or beakers reaches the water level line.
- Place the beakers in a beaker positioning cover, an insert tray or an insert basket to fit your unit, or place the beakers and flasks onto a Branson support rack. Beakers should not touch the tank's bottom.

Cleaning solutions

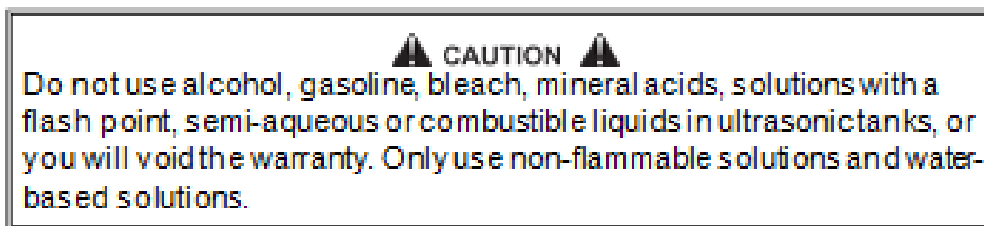

Solution Types

Water-based solutions can be either slightly acidic or alkaline. They include detergents, soaps and industrial cleaners designed to remove specific soils.

Acidic water-based solutions: remove rust, tarnish or scale. They range from mild solutions that remove tarnish, to concentrated, inhibited acidic solutions that remove investment plaster, milk-stone, zinc oxide and rust from steel and cast iron as well as smut and heat-treat scale from hardened steel.

Alkaline water-based solutions: include carbonates, silicates and caustics. These cause emulsifying action, which keeps soil from redepositing on the cleaned surface, and improves cleaning action in hard water.

Alkaline strength	Removes
Mild	Light oils and greases, cutting oils and coolant compounds.
Mild to strong	Heavy grease and oil, waxes, vegetable oils, inks, wax or fat-base buffing and polishing compounds, milk residues and carbohydrates.
Heavy-duty	Mill scale, heat-treat scale, corrosion or oxides.

Electron Microscopy Sciences

1560 Industry Road Hatfield, PA 19440 P.O. Box 550

TEL: 215-412-8400 FAX: 215-412-8450

EMAIL: sgkck@aol.com WEB: www.emsdiasum.com

Change the cleaning solution periodically. Cleaning solutions can become contaminated with suspended soil particles which coat the tank bottom. This coating dampens the ultrasonic action and reduces cleaning efficiency. Certain solutions will cavitate better than others. Contact your local distributor for further information.

Heat and cavitation - increase the chemical activity of cleaning solutions. Some materials may be damaged by this stronger chemical action. When in doubt, test run samples of items to be cleaned.

Caustic solutions: used to remove rust from steels, metal alloy corrosion and a variety of tenacious soils.

Solution Amounts

Solution amounts may vary. The amount you use depends on the detergent and the type of soil to be removed. Follow instructions on the solution container and refer to the table below for the effects of solutions on metals.

Chemicals harmful to your tank

The following chemicals will harm your ultrasonic tank and the action of ultrasonics and higher operating temperatures will increase their chemical activity. Do not use these or similar chemicals directly or in dilution in your ultrasonic tank or you will void your warranty.

Acetophenone	Chloroacetic Acid	Hydrocyanic Acid
Aluminum Chloride	Chloric Acid	Hydrofluoric Acid
Aluminum Fluoride	Chlorine, Anhydrous	Hydrofluosilicic Acid
Aluminum Sulphate	Chromic Acid	Iodoform
Ammonium Bifluoride	Copper Chloride	Mercuric Chloride
Ammonium Chloride	Copper Fluoborate	Muriatic Acid
Ammonium Hydroxide	Ethyl Chloride	Phosphoric (crude)
Amyl Chloride	Ferric Chloride	Sodium Hypochlorite
Antimony Trichloride	Ferrous Chloride	Potassium Chloride
Aqua Regia	Ferris Sulfate	Stannic Chloride
Bromine	Fluoboric Acid	Stannous Chloride
Calcium Bisulfate	Fluorine	Sulfur chloride
Calcium Bisulfite	Hydrobromic Acid	Sulfuric Acid
Calcium Hypochloride	Hydrochloric Acid	Zinc Chloride

Electron Microscopy Sciences

1560 Industry Road Hatfield, PA 19440 P.O. Box 550

TEL: 215-412-8400 FAX: 215-412-8450

EMAIL: sgkcck@aol.com WEB: www.emsdiasum.com

Solution effects on metals

Cleaning Agent *	Steel	Brass	Aluminum	Magnesium	Zinc	S. Steel Copper	Tin
Optical (1)	none	none	none	none **	none **	none	none **
Jewelry (1)	none	none	none	none	none	none	none
Buffing (1) compound	none	slight stain	none	none	attacks	none	none
Oxide (2) remover	slight etch	none	slight attack	attacks	attacks	none	none
Electronic cleaner (1)	none	none	slight attack	none	none	none	none
General(1) purpose	none	none	slight attack	none	none	none	none
Industrial strength(1)	none	none	slight attack	none	none	none	none
Metal (1) cleaner 1	none	none	none	none	none	none	none
Metal (1) cleaner 2	none	none	slight attack	none	none	none	none
Metal (1) cleaner 3	none	none	none	none	none	none	none
Liquid Rust (3) stripper	none	none	attacks ***	attacks ***	attacks	none	slight attack
GP (1) Powder	none	none	none	none	none	none	none

* Contact distributor for cleaning agent availability outside the U.S.

**No effect if solution temperature is less than 60C (140F)

(1) = Alkaline, (2) = Acidic, (3) = Caustic

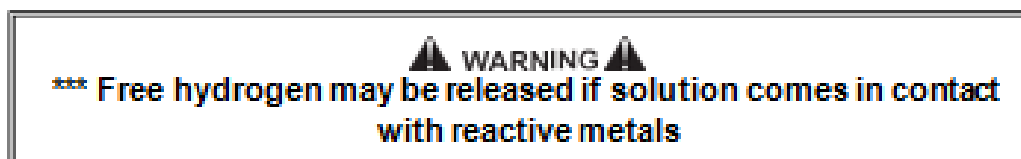

Electron Microscopy Sciences

1560 Industry Road Hatfield, PA 19440 P.O. Box 550

TEL: 215-412-8400 FAX: 215-412-8450

EMAIL: sgkcck@aol.com WEB: www.emsdiasum.com

Troubleshooting

If your unit does not operate satisfactorily, please check the tables below for possible causes before calling your authorized service center.

▲ WARNING ▲
High voltage inside - dangerous shock hazard.
DO NOT attempt to disassemble or repair the unit.

Problem	Cause	What to do
Unit will not start.	Unit not plugged in properly. M/MH - Mechanical timer not ON. CPX/CPXH - POWER switch not ON. CPX/CPXH - On/Standby key malfunctioning. Blown fuse.	Plug into functioning electrical outlet. Turn timer clockwise. Press power switch ON. Call nearest authorized service center. Call nearest authorized service center.
Unit operates but does not heat solution	Heater malfunctions. MH - HEAT not ON. CPXH - HEAT not set properly. CPXH - membrane malfunctioning.	Call nearest authorized service center. Turn heat ON See "Operating your Unit". Call nearest authorized service center.
Clogged drain	Clogged drain.	Call nearest authorized service center.
GFI protected outlet trips	Units may cause GFI circuit trips.	Connect unit to an unprotected outlet
Unit operates but does not reach set temperature	Malfunctioning heater or sensor components.	Call nearest authorized service center.

Electron Microscopy Sciences

1560 Industry Road Hatfield, PA 19440 P.O. Box 550

TEL: 215-412-8400 FAX: 215-412-8450

EMAIL: sgkcck@aol.com WEB: www.emsdiasum.com

▲▲ WARNING ▲▲
High voltage inside - dangerous shock hazard.
DO NOT attempt to disassemble or repair the unit

Problem	Cause	What to do
Err on actual temp and alarm icon is on. Sonics and degas operate. Auto and Heat are inactive.	Malfunctioning sensor components.	Call nearest authorized service center.
Unit operates but display does not function.	CPX/CPXH - Control board malfunctioning.	Call nearest authorized service center.
Unit stops operating and display is blank with only alarm icon on.	Overheat condition.	Turn unit off. Allow unit to cool, check solution level, then restart. Refer to page 40 for information on over temperature protection.
Decreased ultrasonic activity. NOTE: Refer to page 53 for cavitation check.	<p>Solution is not degassed.</p> <p>Solution is spent.</p> <p>Solution level is incorrect for load.</p> <p>Tank bottom is covered with soil particles.</p> <p>Using deionized water in the tank.</p>	<p>Make sure that tank was filled with warm tap water plus cleaning solution and has run 5–10 minutes.</p> <p>Change solution.</p> <p>Adjust solution to within 3/8 inch (1 cm) of the tank's operating level line with load.</p> <p>Empty, then clean tank with warm water. Wipe with a nonabrasive cloth.</p> <p>Deionized water does not cavitate as actively as soapy tap water.</p>

Electron Microscopy Sciences

1560 Industry Road Hatfield, PA 19440 P.O. Box 550

TEL: 215-412-8400 FAX: 215-412-8450

EMAIL: sgkck@aol.com WEB: www.emsdiasum.com

Glass Slide Test

Check your ultrasonic bath periodically to test the level of activity of the ultrasonic cavitation. Frequency of testing will depend on your use of the unit, however, Branson suggests running this test monthly.

You will need the following equipment:

- Frosted microscope glass slide (1" x 3") frosted microscope slides, or equivalent
- No. 2 lead pencil
- General purpose household cleaning solution, such as Dawn[®] liquid soap.

Test procedure:

1. Prepare a fresh solution with general purpose household cleaning solution (concentration 1%) and warm tap water 49 °C – 60 °C (120 °F – 140 °F).
2. Fill the tank to within 3/8 inch (1 cm) of the "operating level" line.
3. Turn the ultrasonics on for at least five to ten minutes to allow for degassing.
4. Prepare the glass slide by first wetting the frosted portion with tap water.

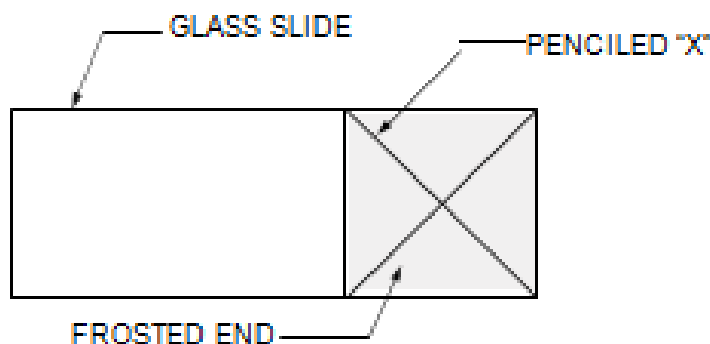

5. With the No. 2 pencil, on the frosted portion make an "X" from corner to corner.
6. Immerse the frosted end of the slide into the solution. Hold the slide vertically and center it in the solution.
7. Make sure that model CPX/CPHX models are in Timed or Constant Sonics Mode, not Degas Mode, and then turn ultrasonics on.

The ultrasonics will begin immediately to remove the lead from the slide. All lead should be removed within 10 seconds. If your unit passes this test, its ultrasonic cavitation is acceptable.

NOTE:

To ensure consistency from test to test, be sure to repeat test conditions—use the same solution concentration, liquid level, temperature, type of pencil, length of degassing, etc.

Electron Microscopy Sciences

1560 Industry Road Hatfield, PA 19440 P.O. Box 550

TEL: 215-412-8400 FAX: 215-412-8450

EMAIL: sgkck@aol.com WEB: www.emsdiasum.com

Information for users on disposal of equipment



This symbol indicates separate collection of waste electrical and electronic equipment in the EU-countries and EEA (European Economic Area)

Please do not dispose the product with the general household waste. Please use the return and collection system in your country for the disposal of this product.

Electron Microscopy Sciences

1560 Industry Road Hatfield, PA 19440 P.O. Box 550

TEL: 215-412-8400 FAX: 215-412-8450

EMAIL: sgkcck@aol.com WEB: www.emsdiasum.com